

Ulrich H. Gysel and John P. Watjen  
 Radio Physics Laboratory  
 Stanford Research Institute  
 Menlo Park, California 94025

### Abstract

A 7-to-11-GHz frequency discriminator with high linearity has been built using microwave integrated circuits (MICs). The critical subcomponent parameters of the discriminator were determined by computer analysis. The key elements of the design are balanced detectors with controlled terminations for internally generated harmonics and a gain equalizer to compensate for frequency-dependent losses. Linearity of the unit is better than  $\pm 0.85\%$ .

### Introduction

Wideband frequency discriminators are used frequently in various ECM applications such as frequency-memory units. A highly linear and ripple-free discriminator response is essential for most applications. Previous microwave line-type discriminators have used discrete components or integrated stripline assemblies, which have a limited accuracy of  $\pm 7\%$  to  $\pm 4\%$ . This paper describes the development of a discriminator with improved linearity and smaller size. The improvements were made possible by extensive analysis of errors in frequency discriminators, the use of microwave integrated circuits (MIC), and the control of the strongest harmonic frequencies generated in the detectors of the discriminator.

### Discriminator Analysis

A schematic diagram of the well-known line-type frequency discriminator is shown in Figure 1. The circuit operates on the principle of converting frequency changes into amplitude changes. The latter are detected by the two detectors and summed in a differential amplifier. For proper operation, the discriminator must be preceded by an amplitude limiter. The analysis of this discriminator is well known.<sup>1</sup> Ideally, the circuit provides an output voltage that is represented by the equation  $V_{OUT} = A \cos \theta$ , with  $\theta$  = electrical length of the delay line, and under the assumption of detectors operating in the square-law region. According to this equation the theoretical frequency error of a discriminator for the 7-to-11 GHz band is  $\pm 10$  MHz, if  $\theta = 90^\circ$  at 9 GHz. These calculations are made on the basis of ideal subcomponents comprising the discriminator. In practice, the performance is limited by the imperfections of the quadrature hybrids, the detectors, and the internal termination. Particularly, multiple reflections in the circuit cause undesired ripples that cannot be compensated for externally.

To understand fully the limitations of a realistically achievable discriminator, a computer program that described and analyzed the circuit in terms of explicit scattering parameters of circuit subcomponents was written. The analysis is based on a matrix formulation of the signal flow graph.<sup>2</sup> Studies with this program revealed the effects of parameters such as coupler isolation or detector mismatches. The computer program calculated the discriminator output voltage and determined the best straight-line approximation to the output voltage, as well as the frequency error with respect to this best straight-line approximation.

The analysis clearly revealed the most sensitive components of the discriminator. The major factors affecting the linearity of the discriminator are given in the following decreasing order of importance:

- (1) The detectors must be exceptionally well matched. Any residual reflections of the two detectors should track with frequency

and be constant over the operating RF power range.

- (2) The two quadrature hybrids must have high isolation; in particular the isolation of the input hybrid is most critical for linearity. However, the linearity is relatively insensitive to coupling imbalances.
- (3) The internal termination must be well matched.
- (4) The connecting line lengths between the components should be kept as short as possible.
- (5) Linearity can be improved by isolation of the components through the use of pads (at the expense of decreased frequency sensitivity).

Multiple reflections between the internal termination or the input hybrid and the unbalanced component of the detector reflections are the most significant contributor to a nonlinear frequency characteristic. An example of the analysis is shown in Figure 2. The circuit parameters are indicated in the circuit schematic; connecting line lengths are typical for an actual circuit. The resulting frequency error is  $\pm 35$  MHz, despite the high performance of the subcomponents. These results indicate the practical limitations of this type of frequency discriminator.

### Discriminator Design and Performance

The frequency discriminator circuit was produced in microstrip using 10-mil sapphire substrates. The final circuit, shown in Figure 3, consists of a gain equalizer preceding the RF input of the actual discriminator, two quadrature hybrids, a delay line section, and two detectors. Each subcomponent was individually tested and optimized before the entire discriminator was integrated.

The quadrature hybrids have 2.8 dB midband coupling and consist of two cascaded 8.08-dB wiggly couplers. These couplers have approximately 25 dB of isolation and a VSWR less than 1.2:1 over the band from 7 to 11 GHz. The internal termination consists of a thin-film resistor and a wrap around the edge of the substrate. The maximum VSWR of this termination is less than 1.1:1.

The detectors are the most complex elements of the discriminator. Their design was chosen to provide a flat response, low VSWR characteristics, and controlled impedances for the higher harmonics that are generated in the detector diodes. These harmonics can cause serious ripples in the response of the discriminator because of multiple reflections, if they are allowed to propagate back into the hybrid portion of the discriminator. In the present design these harmonics are contained in the detector circuit by designing the matching networks for the detector diodes as lowpass filters that reactively terminate the harmonics. The stopband

requirements of these filters are eased by the use of an anti-parallel diode pair, which has the effect of canceling all even harmonics in the external circuit. The basic circuit diagram of the detector is shown in Figure 4. The lowpass filter LP1 passes the fundamental RF signal and is designed to stop the third harmonic ( $\geq 30$  dB of attenuation). The lowpass filters LP2 stop the RF signals and allow extraction of the video signals. Computer optimization and several experimental iterations were required to find an optimum circuit. Figure 5 shows the theoretical passband VSWR and stopband attenuation of the detector circuit as well as the impedance seen from the junction resistance of each diode at the second and third harmonic. Matched sets of four Schottky-barrier beam-lead diodes were used. The diodes are externally biased because of the relatively low input power level--10 dB for each detector. The final detector circuit had a maximum VSWR of 1.2:1 (including connector) and a very smooth frequency response. However, the output voltage dropped 12% over the band because of circuit losses that increase with frequency.

The drop in output voltage of the detectors, together with other frequency-dependent circuit losses, causes the discriminator to have an output voltage with a constant curvature. A typical response is shown in Figure 6 (marked "not linearized"). This output voltage curvature is removed by the gain equalizer, which linearizes the response at the expense of a decreased voltage swing. The linearized output voltage is also shown in Figure 6 together with a plot of the frequency error with respect to a best straight-line approximation. The maximum frequency error does not exceed  $\pm 33$  MHz and thus is less than  $\pm 0.85\%$  of the total frequency range. The nominal input power for the discriminator for these measurements was  $-6$  dBm.

The equalizer is conventionally designed and consists of two short-circuited stubs, one-quarter wavelength long at 12 GHz, that are connected to the mainline by thin-film resistors. This equalizer has minimum loss at 12 GHz and its attenuation drops almost linearly by 1.6 dB from 7 to 11 GHz.

The overall frequency discriminator includes a high-speed operational amplifier to sum the outputs of the four detector diodes and to isolate the diodes from the video output load. In addition the video circuit provides bias for the diodes. The amplifier has 20 dB gain and a total response time of 25 ns (to 1% settling time).

The difficult task of measuring the discriminator and adjusting the diode biases for best linearity of the response was accomplished with the help of an automatic network analyzer (ANA). The ANA was used principally to provide a computer-controlled, frequency-synthesized signal source of a known power level. Data acquisition and processing were done by the ANA computer. This

system allowed, after a calibration phase, a measurement over the 7 to 11 GHz band in less than one minute, and the display of the frequency deviation from a best straight line approximation on the ANA graphics display. Measurement accuracy is better than  $\pm 16$  MHz at the band edges and  $\pm 5$  MHz at the band center.

### Conclusions

Two major goals were achieved during the development of this frequency discriminator. First, a computer program was written that gave the necessary insight into the sources of errors in a line discriminator. This program was instrumental in determining specifications for the subcomponents of such a discriminator designed to achieve a certain maximum frequency error. Second, an integrated-circuit discriminator was built using microstrip line on 10-mil-thick sapphire. The frequency-error of this discriminator,  $\pm 33$  MHz, is in close agreement with computer simulations, and is at least a factor of four better than that of any previously known discriminator.

Important for the high linearity of the discriminator are the MIC techniques that eliminate numerous interconnections normally present in a circuit with discrete components; MICs thus remove the origin of deleterious discontinuity VSWRs. Furthermore, the control of harmonics generated in the detector diodes is considered essential for the high performance of the discriminator. The present design is limited by the small but finite reflections of the subcomponents, mostly the detectors, the input quadrature hybrid, and the internal termination. A further reduction of the frequency error appears very difficult, and new designs will probably be required.

### Acknowledgment

This work was supported by the Naval Electronics Systems Command, Washington, D.C., under Contract N00039-75-C-0404. The authors would like to thank Mr. A.K. Gorwara, former Project Supervisor, for his many contributions to this program.

### References

1. R.J. Mohr, "Broadband-Band Microwave Discriminator," IEEE Trans. on Microwave Theory and Techniques, Vol. MTT-11, pp. 263-264 (July 1963).
2. A.Y. Lee, "Signal-Flow Graph-Computer-Aided System Analysis and Sensitivity Calculations," IEEE Trans. on Circuits and Systems, Vol. CAS-21, pp. 209-216 (March 1974).

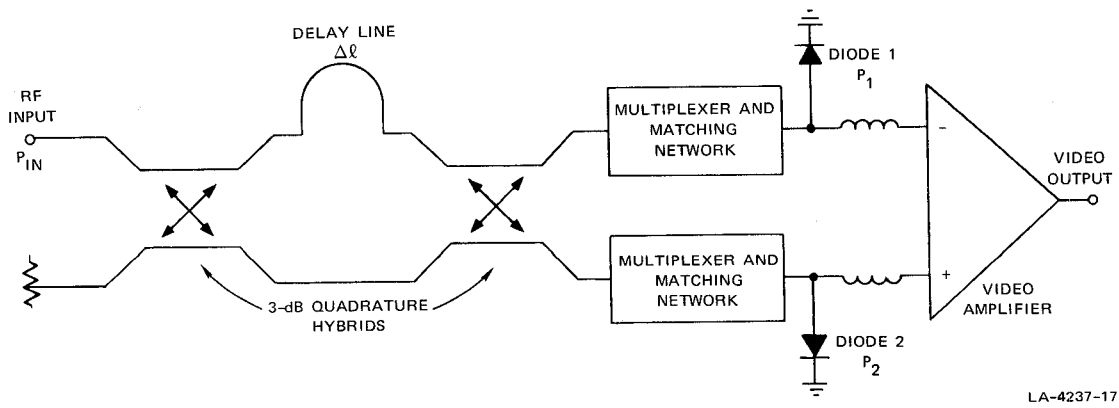

LA-4237-17

FIGURE 1 SCHEMATIC OF FREQUENCY DISCRIMINATOR

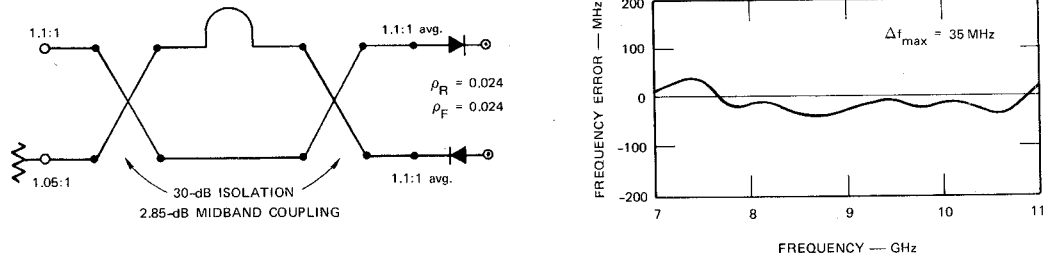

LA-4237-26

FIGURE 2 THEORETICAL FREQUENCY ERROR OF DISCRIMINATOR

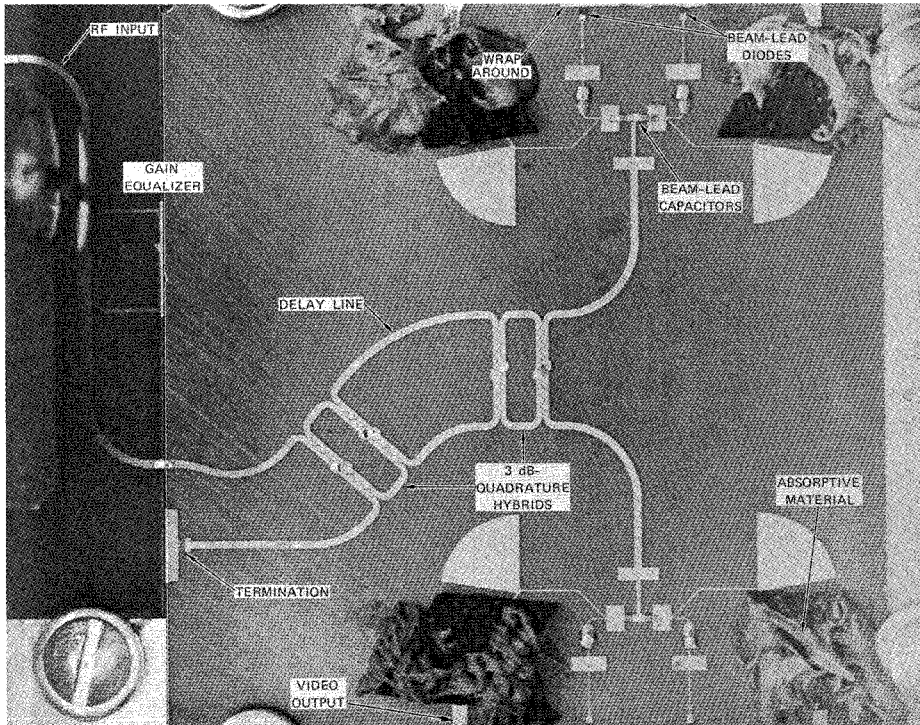

FIGURE 3 PHOTOGRAPH OF THE FREQUENCY-DISCRIMINATOR MIC CIRCUIT WITH GAIN EQUALIZER

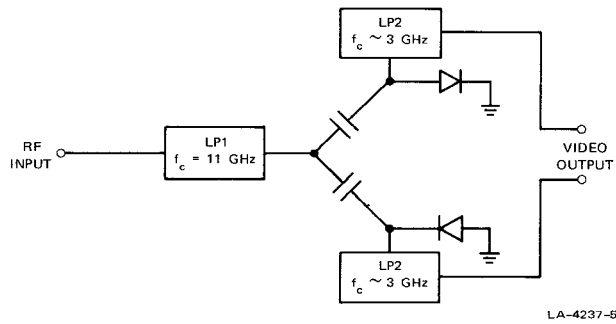
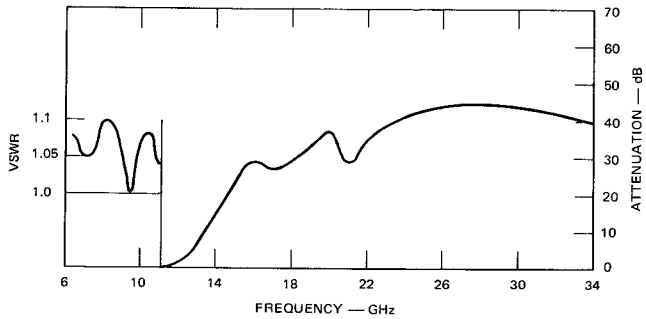
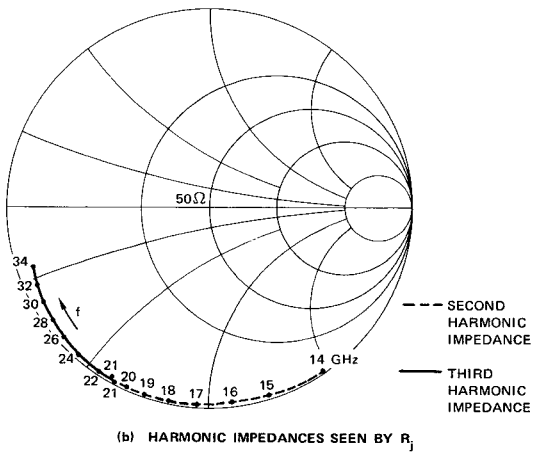

FIGURE 4 DETECTOR CIRCUIT WITH REACTIVELY TERMINATED HARMONICS



(a) VSWR AND ATTENUATION



(b) HARMONIC IMPEDANCES SEEN BY  $R_1$

LA-4237-38

FIGURE 5 THEORETICAL PERFORMANCE OF DETECTOR

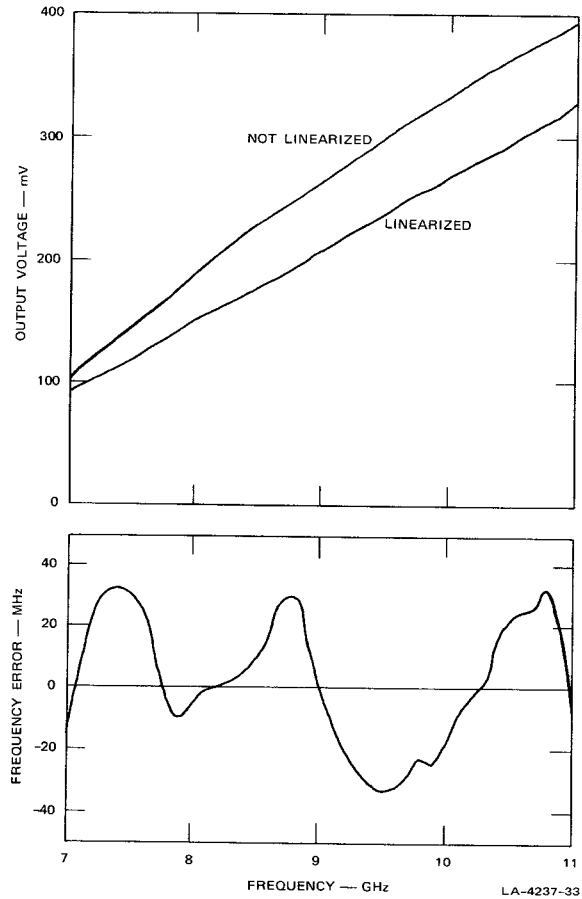

FIGURE 6 OUTPUT VOLTAGE AND FREQUENCY ERROR OF LINEARIZED DISCRIMINATOR

LA-4237-33